



## ADO ŘADOVÁ SVORKA PROPOJOVACÍ D4/8

39924414

D4/8.ado 4,00 mm šedá

- 4 mm<sup>2</sup> / 32 A
- 8 mm široký

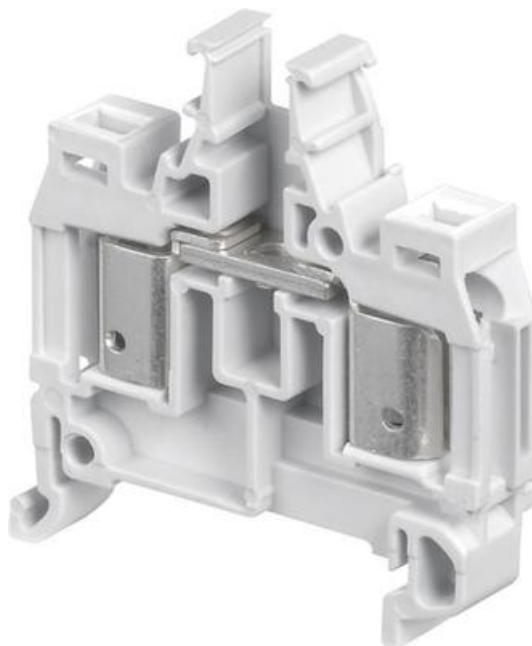

### POPIS PRODUKTU

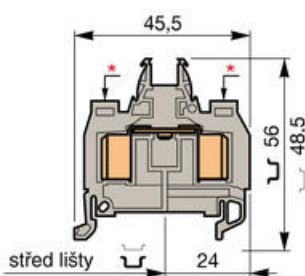

Standardní svorka  
Šířka 8 mm

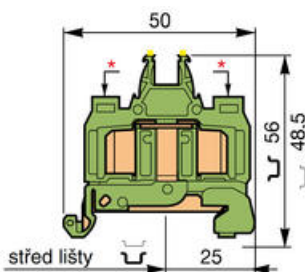

Zemní svorka  
Šířka 8 mm

ADO-pro průřez vodiče 4 mm<sup>2</sup>

### TECHNICKÉ PARAMETRY





IEC  
NFC

UL  
VDE

CSA

Průřez vodiče ADO - pevný	4 mm <sup>2</sup>	14-12 AWG	14-12 AWG
Průřez vodiče ADO - lankový	4 mm <sup>2</sup>	14-12 AWG	14-12 AWG
Jmenovité napětí (V st/ss)	1000	600	600
Jmenovitý proud (A)	32	30	25
Jmenovitý průřez	4 mm <sup>2</sup>	12 AWG	12 AWG

## OBJEDNACÍ INFORMACE













Popis	Barva	Typ	Obj.č.	E-kód	Balení
4.00 mm ADO-ADO šedá		D4/8.ADO	39924414	E2925806	50
4.00 mm ADO-ADO modrá		D4/8.N.ADO	39931816	E2925806	
4.00 mm ADO-ADO oranžová		D4/8..ADO	39980104	E2925807	
4.00 mm ADO-ADO zemní s kostřením na lištu		D4/8.P ADO	39925026	E2925828	

## DOPLŇKY

Popis	Poznámka	Typ	Objednací čísla	E-kód	Balení
Lišta, neperforovaná 35x7,5x1 (2 m)		TS35	TS35	E2929954	20x2 m
Lišta, perforovaná, 35x7,5x1 (2 m)		TS35F	TS35/F5	E2929953	
Lišta, vysoká neperforovaná 35x15x1.5 (2 m)		TS35C	TS35/C	E2929956	10x2 m
Koncovka		BADL	39990302	E2925699	50
Krajní stěna, ADO-ADO		FEMAD3	19934105	E2925860	20
Krajní stěna, ADO-ADO, žlutá		FEMAD3	19934307		
Oddělovač obvodů ADO		SCAD	19689600		
Testovací zdička 2 mm/12 mm		AL2	16304321	E2925663	10
Testovací zdička 3 mm/ 9,5 mm		AL3	16326100		
Testovací zdička 4 mm		AL4	16324017	E2925664	
Testovací banánek		FC2	00786526	E2925658	
		FC4	16786001	E2925659	
Zkratovací propojka	2-pólová	BJM6	16852005		
	3-pólová		16852122		
	4-pólová		16852223		
	5-pólová		16852324		
	10-pólová		16897400	E2925702	
Zkratovací pásek 20-pólový, (bez šroubů)		BJS8	17478905		
Šroub pro BJS6/BJS8/BJS10		EV6	16860416	E2925667	100
Otočná zkratovací propojka		BJP8	17444807	E2925674	10
Zkratovací propojka		EL6	17362721		

Ochranný štítek	EP6	16342717		
Ochranný štítek	EP8	16342820		
Šroub pro EP6/EP8	VSP6	16343315		20
Ruční nástroj, ADO	OUMAD	17946606	E1647040	1
Ruční automatický nástroj, ADO	OUPAD	17894404	E1647041	
Kit výměnné hlavy, ADO	OUTA	20528403	E2925799	

#### Popisy RC610

	
BADL	FEMAD3
	
SCAD	AL2, AL3
	
FC2, FC4	
	
BJM8	BJS8, EV6
	
EL6	EP6, EP8
	
OUMAD	OUPAD, OUTA
	
RC810	

## SPECIFIKACE

<b>Barva</b>	Šedá
<b>Jmenovité napětí dle CSA</b>	600 V
<b>Jmenovité napětí dle IEC</b>	1000 V
<b>Jmenovité napětí dle UL</b>	600 V
<b>Jmenovitý proud dle CSA</b>	25 A
<b>Jmenovitý proud dle IEC</b>	32 A
<b>Jmenovitý proud dle UL</b>	30 A
<b>Jmenovitý průřez dle CSA</b>	12 AWG

Jmenovitý průřez dle IEC	4 mm <sup>2</sup>
Jmenovitý průřez dle UL	12 AWG
Min. průřez laněného vodiče ADO svorky dle IEC	4 mm <sup>2</sup>
Min. průřez pevného vodiče ADO svorky dle IEC	4 mm <sup>2</sup>

