



ADO ODPOJOVACÍ SVORKA D2.5/8.SNT2

19923127

D2,5/8.SNT2.ADO-ADO 1,00-2,5 mm

- 2,5 mm²/ 15 A
- 8 mm široký

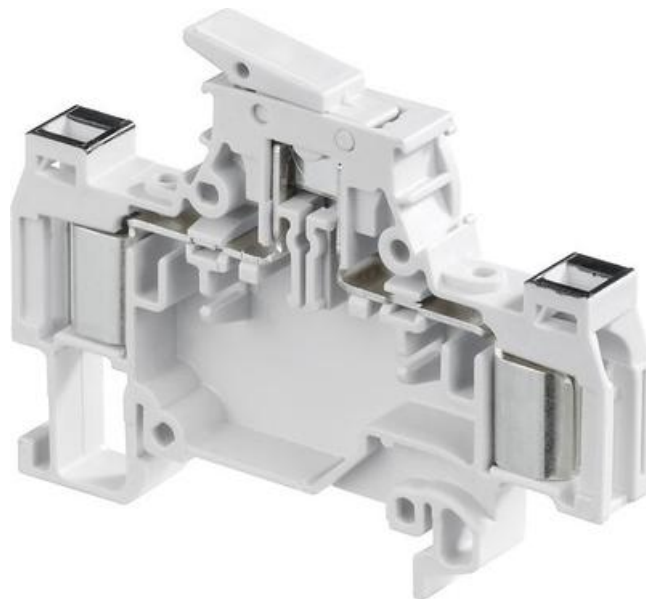

POPIS PRODUKTU

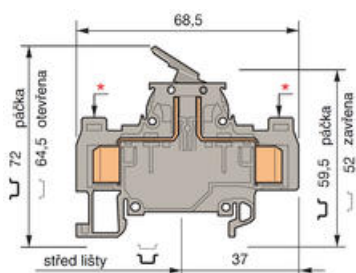

Šířka 8 mm

ADO-pro průřez vodiče 1 - 2.5 mm²* Poznámka => část 1 - 2.5 mm²**D2.5/8.SNT2.ADO** s testovací zdičkou Ø 2 mm na obou stranách.**D2.5/8.SNT23.ADO** s testovací zdičkou Ø 2,3 mm na obou stranách.

TECHNICKÉ PARAMETRY

	IEC NFC	UL VDE	CSA
Průřez vodiče mm ² /AWG ADO - pevný	1-2.5 mm ²	16 - 14 AWG	16 - 14 AWG
Průřez vodiče mm ² /AWG ADO - lankový	1-2.5 mm ²	16 - 14 AWG	16 - 14 AWG
Jmenovité napětí (V st/ss)	320	300	300
Jmenovitý proud (A)	15	15	15
Jmenovitý průřez	2.5 mm ²	14 AWG	14 AWG







OBJEDNACÍ INFORMACE

Popis	Barva	Typ	Obj.č.	E-kód	Balení
1.0-2.5 mm		D2.5/8.SNT2 ADO-ADO	19923127		50
1-2.5 mm ADO-ADO odpojovač, testovací zdičky 2.3 mm		D2.5/8.SNT2.3 ADO-ADO	19923321		
1.0-2.5 mm oranžová		D2.5/8.SNT2 ADO-ADO	19923220		

DOPLŇKY

Popis	Poznámka	Typ	Objednací čísla	E-kód	Balení
Lišta, neperforovaná 35x7,5x1 (2 m)		TS35	TS35	E2929954	20x2 m
Lišta, perforovaná, 35x7,5x1 (2 m)		TS35F	TS35/F5	E2929953	
Lišta, vysoká neperforovaná 35x15x1.5 (2 m)		TS35C	TS35/C	E2929956	10x2 m
Koncovka		BADL	39990302	E2925699	50
Krajní stěna, SN-ADO		FEDAD5	19935402		20
Testovací banánek		FC2	786526	E2925658	10
Ruční nástroj, ADO		OUMAD	17946606	E1647040	1
Ruční automatický nástroj, ADO		OUPAD	17894404	E1647041	
Kit výměnné hlavy, ADO		OUTA	20528403	E2925799	

Popisy RC610

	
BADL	FEDAD5
	
FC2	OUMAD
	
OUPAD, OUTA	RC810

