

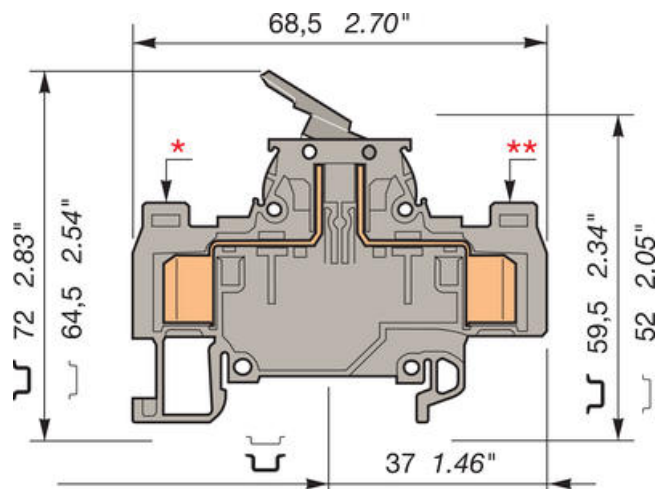

ADO2 ODPOJOVACÍ SVORKA D2.5/8.SNT2.

39975413

D2,5/8.SNT2.ADO ADO2 Odnímatelné



POPIS PRODUKTU

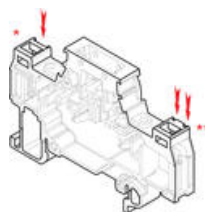
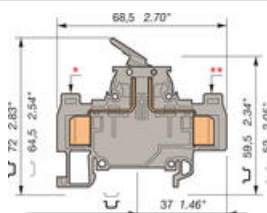

Šířka 8 mm

* ADO = 0.22-1 mm²** ADO = 1-2.5 mm²* ADO = 0.22-1 mm²** ADO = 1-2.5 mm²

TECHNICKÉ PARAMETRY

	IEC NFC VDE	UL	CSA
Průřez vodiče - pevný	1-2.5 mm ²	16 - 14 AWG	16 - 14 AWG
Průřez vodiče - lankový	1-2.5 mm ²	16 - 14 AWG	16 - 14 AWG
Jmenovité napětí (V st/ss)	500	600	600
Zkratová odolnost (kV)	6		
Stupeň znečištění	3		
Jmenovitý proud (A)	10	10	10
Jmenovitý průřez	1 mm ²	14 AWG	14 AWG





OBJEDNACÍ INFOMACE

Popis	Barva	Typ	Obj.č.	E-kód	Balení
D2.5/8.SNT2.ADO ADO2 odpojovací		D2.5/8.SNT2.ADO ADO2	39975413		50

DOPLŇKY

Popis	Poznámka	Typ	Obj.č.	E-kód	Balení
Krajní stěna, SN-ADO		FEDAD5	19935402		20
Testovací banánek		FC2	00786526	E2925658	10
Ruční nástroj, ADO		OUMAD	17946606	E1647040	1
Ruční automatický nástroj, ADO		OUPAD	17894404	E1647041	
Pneumatický nástroj, ADO		OUTPAD	20571011		
Kit výměnné hlavy, ADO		OUTA	20528403	E2925799	
Nástroj na vyjmutí vodiče		EXAD2	20572100		

Popisy RC610

	
FEDAD5	FC2
	
OUPAD	OUMAD
	
RC810	

